

3 611 B50 500

Issue } 14-06-23  
Stand } **Fig./Abb. 2**

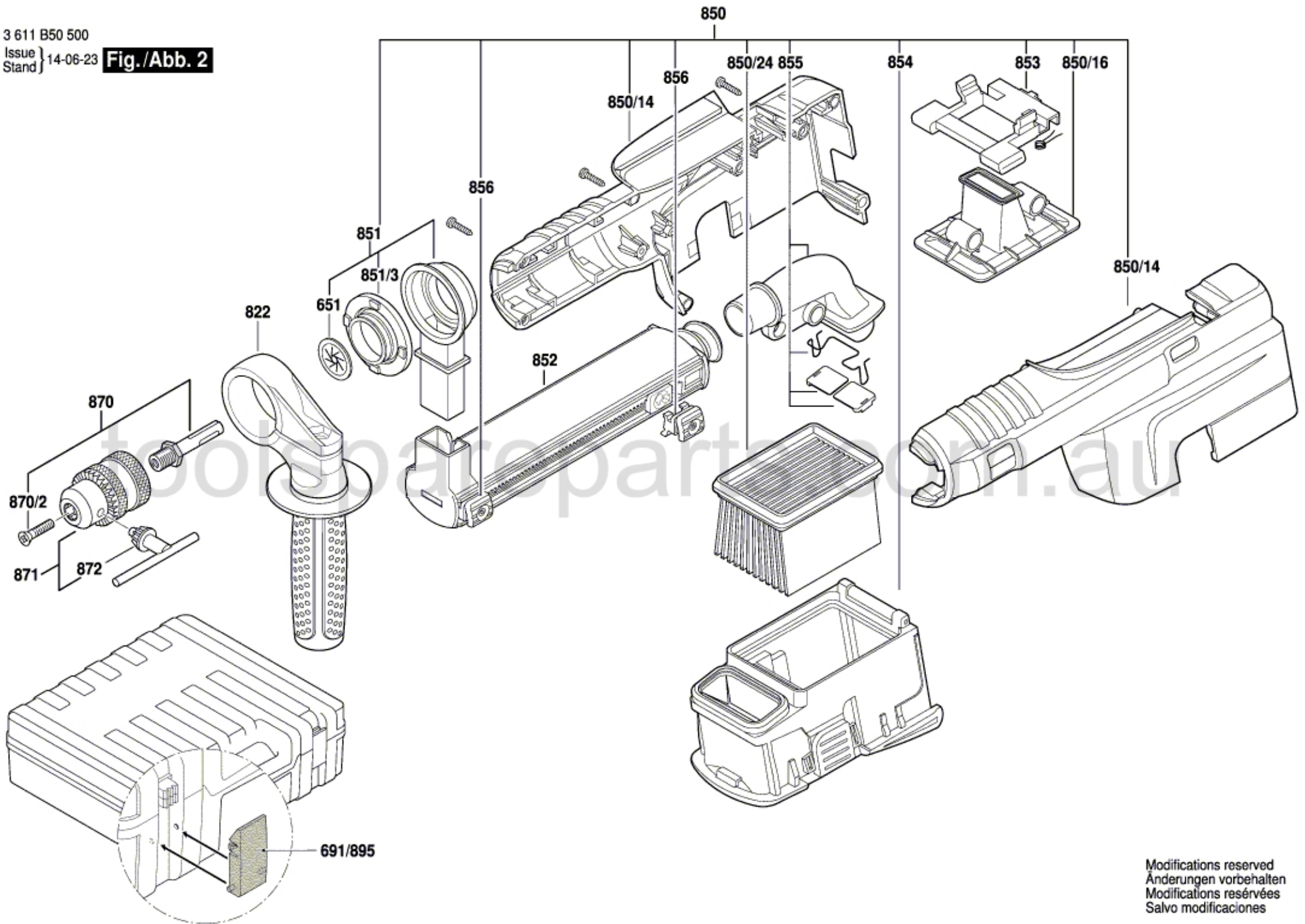

Modifications reserved  
Änderungen vorbehalten  
Modifications réservées  
Salvo modificaciones